



**WI-CPE513P-KIT / WI-CPE111-KIT**

**Wireless CPE for CCTV Quick Install Guide**

**Package content**

**WI-CPE513P-KIT**

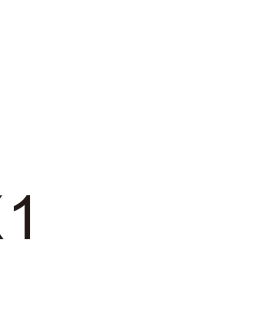

X1

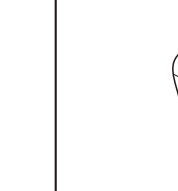

X1



X1

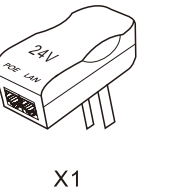

X1

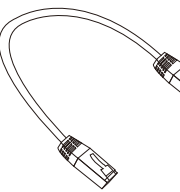

X1

**Package content**

**WI-CPE111-KIT**



X1

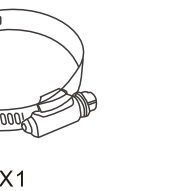

X1



X1

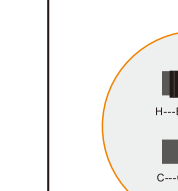

X1

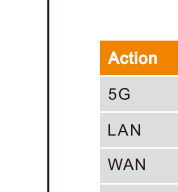

X1

**Hardware Overview**

**WI-CPE513P-KIT**



**LED Channel Display**

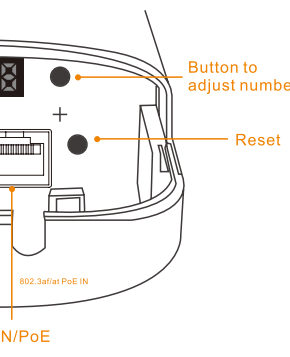

Action	Status Indication
5G	Off -- Pairing failed; Solid green--Paired successfully
LAN	Off -- No link; Solid green -- Link activated
WAN	Off -- No link; Solid green -- Link activated
SYS	Off -- Power off; Solid green -- working

**WI-CPE111-KIT**

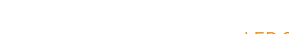

**LED Channel Display**

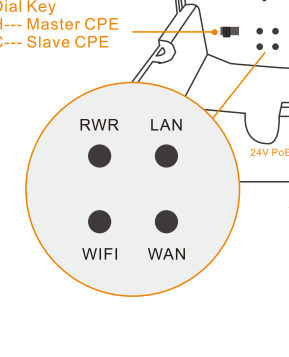

Action	Status Indication
WIFI	Off -- Pairing failed; Solid green--Paired successfully
LAN	Off -- No link; Solid green -- Link activated
WAN	Off -- No link; Solid green -- Link activated
SYS	Off -- Power off; Solid green -- working

**Mounting**

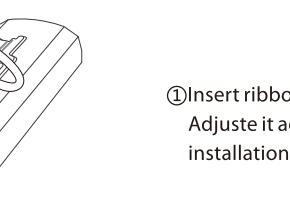

① Insert ribbon at the backside bracket hole. Adjust it according to the pole size and installation position.



② Install the device on the pole and tighten the ribbon.

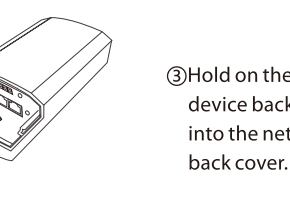

③ Hold on the buckle to take down the device back cover. Insert the net cable into the network port, then fasten the back cover.

**Network application**

**WI-CPE513P-KIT V3**

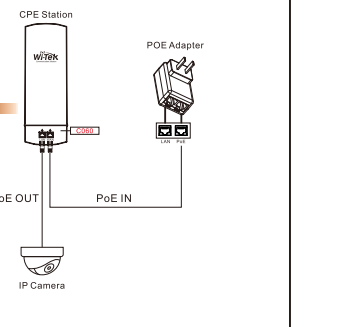

**WI-CPE111-KIT V2**

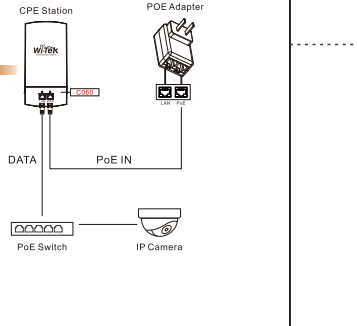

**Configuration steps**

1. Set one device to Basic Station, and Another to CPE.



**Cloud Management Setting(Optional)**

2. Set same number: select the devices, Long press on-in 3S, the LED Channel Display is flashing red, and then adjust the number. (Press "+" or "-" button to change the number)

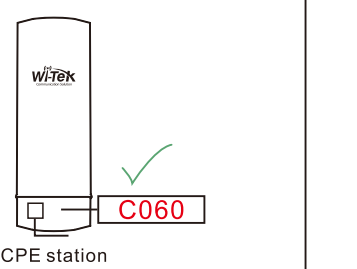

OR

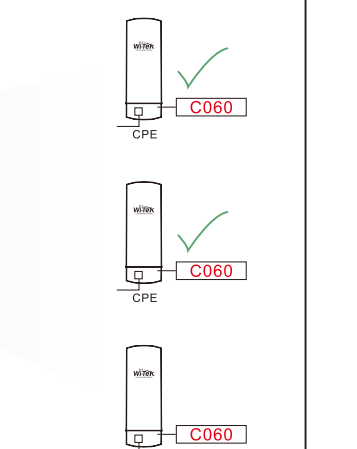

**Cloud Management Setting(Optional)**

Step 1: Enter <http://cloud2.wireless-tek.com>, Register and log in Wi-Tek Cloud by email.

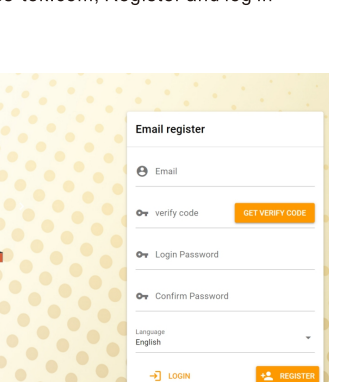

Step 2: Go to Dashboard > ADD NETWORK

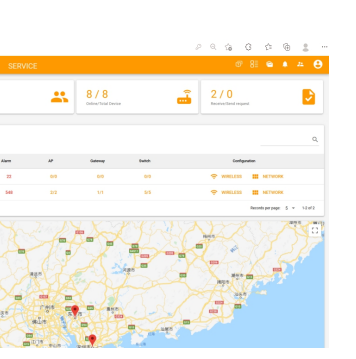

**Cloud Management Setting(Optional)**

Step 3: Fill in the device info and **SAVE**. (Note: A good name and exact location info can help you maintain devices easily)

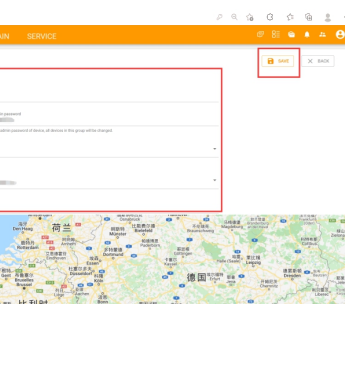

Step 4: Then Click Next

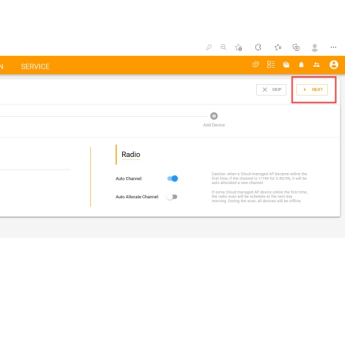

**Cloud Management Setting(Optional)**

Step 5: Fill in the Basic Station serial number (The 17-digit SN code is shown on the label of the device back), ADD and FINISHED, you can see the green label -- Add Success.

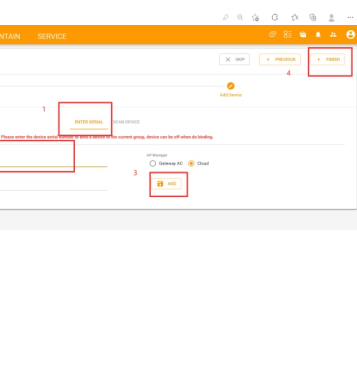

Step 6: Go to Device >CPE, click **REFRESH**, and you can see the device status.

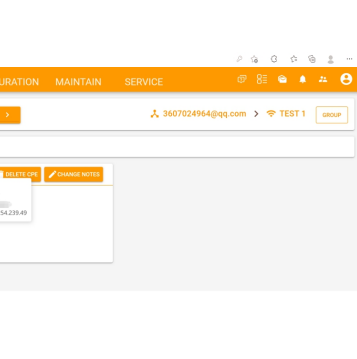

**Cloud Management Setting(Optional)**

Step 7: Click **ADD DEVICE**, in the CPE serial number (The 17-digit SN code is shown on the label of the device back), ADD and **SAVE**.

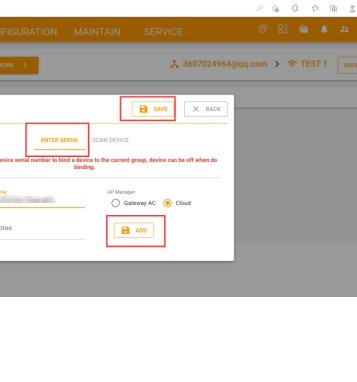

Step 8: Finally, click **REFRESH**, and you can see the two device are connected.

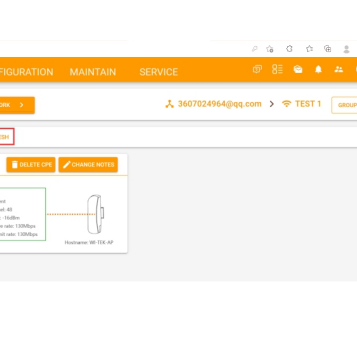

**How to find the IP address of the device**

1. Hook computer up to the LAN port of CPE, keep IP address on the same segment.

2. Use the AP Tools to scan device IP

(Download link <https://drive.google.com/file/d/17WYyRjLMNS5NsEWesOIMzHUsvmRU3q/view?usp=sharing>)

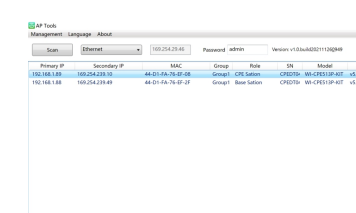

**Warranty Card**

Username	
Address	
Telephone No.	
Purchase Shop	
Purchase Address	
Product Model No.	
Purchase Time	
Serial No.	
Dealer Signature	

- If the product defects within three months after purchase, we will provide you a new product of the same model.
- If the product defects within the three-year warranty period, we will provide the professional maintenance service.
- Proof of purchase and a complete product serial number are required to receive any services guaranteed as part of the limited warranty.
- Any other defects that are not caused by workmanship or product quality, such as natural disaster, water damage, extreme thermal or environmental conditions, sticker damaged, warranty card losing will disqualify the product from limited warranty.



Wireless-Tek Technology Limited  
 Address: Room 402 4F, BiaoFan Technology Building, Bao'An Avenue, FuYong Town, Bao'An district, ShenZhen  
 Website: www.wireless-tek.com  
 Tel: 86-0755-32811290  
 Email: sales@wireless-tek.com  
 Technical Support: tech@wireless-tek.com

